



WWW.SIMONRACK.COM



ACCESSORIES



Management System
ISO 9001:2015
www.tuv.com
ID 9105044225



ACCESORIOS • ACCESSORIES • ZUBEHÖR • ACCESSOIRES



- C** SIMONCLASSIC
- C** SIMONCLICK
- T** SIMONTALLER
- A** SIMONAUTO
- B** SIMONWORK
- O** SIMONOFFICE
- H** SIMONHOME

Pies de plástico/Plastic feet/Kunststofffuß/Pieds en plastique

Description	EAN Code	EAN Code	€/Unit	Unit Pack.
Blisters 4 pies / feet P/35 (A)	8425437039942	8425437040092	3,84 €	12
Blisters 4 pies / feet P/40	8425437039997	8425437040146	3,84 €	12
Bolsa 4 Pies P/50 Grises (B)	8435104986325	---	3,15 €	
Caja/Box 48 pies/feet P/35	8425437039973	8425437040122	9,77 €	3
Caja/Box 100 pies/feet P/35	8425437039980	8425437040139	20,38 €	3
Caja/Box 48 pies/feet P/40 (C)	8425437041204	8425437040177	11,68 €	3
Caja/Box 100 pies/feet P/40 (D)	8425437040030	8425437040184	21,21 €	3
Caja/Box 48 pies/feet dobles/doubles P/35*	8425437041181	----	20,19 €	3
Caja/Box 48 pies/feet dobles/doubles P/40*	8425437041198	----	21,51 €	3
Saco/Bag 1500 pies/feet P/35	8425437041280	8425437040306	271,63 €	1
Saco/Bag 1500 pies/feet P/40 (E)	8425437040290	8425437042058	288,45 €	1
Caja/Box 48 pies/feet P/50	8435104914489	----	14,52 €	3
Saco/Bag 1000 pies/feet P/50	8435104914496	----	262,67 €	1

* Incompatible pletina de unión / Incompatible Union plate / Inkompatible Verbindungsplatte / Plaquette d'union Incompatibilité

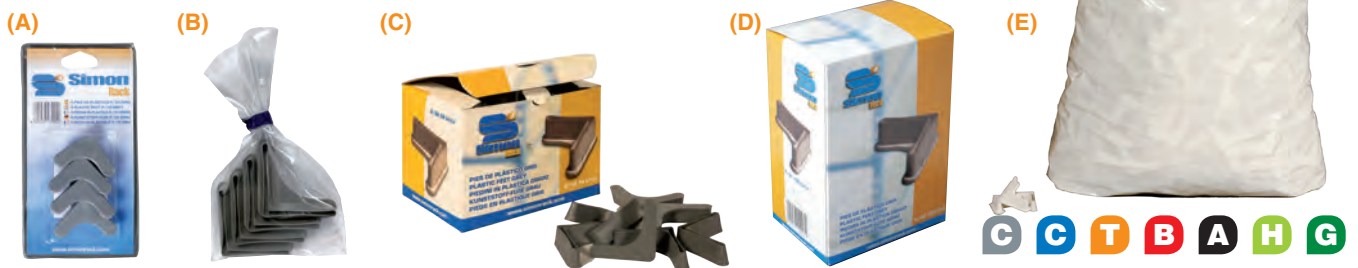

Topes Officlick/Officlick stoppers/Officlick Schützabschluss/Bouchons en plastique

Description	EAN Code	€/Unit	Unit Pack.
Blisters 4 topes blancos/white stoppers Officlick	8435104913970	4,39 €	12
Blisters 4 topes grises/grey stoppers Officlick (A)	8435104913987	4,39 €	12
Caja/Box 48 topes/stoppers blancos/white Officlick	8435104913994	14,41 €	3
Caja/Box 48 topes/stoppers grises/grey Officlick (B)	8435104914007	14,41 €	3

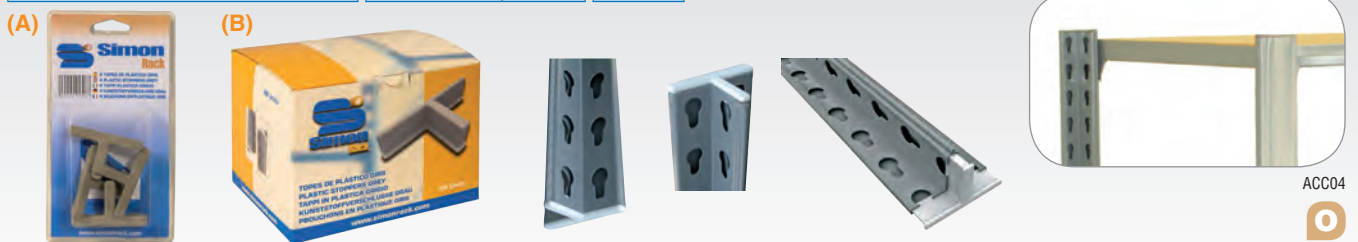

Classiclip

Description	EAN Code	€/Unit	Unit Pack.
Blisters 12 Classiclips (A)	8425437040436	8,68 €	10
Caja/Box 100 Classiclips (B)	8425437040443	61,57 €	1
Saco/Bag 1200 Classiclips	8425437040450	651,26 €	1



Gancho Ecoclick/Ecoclick Clip/Ecoclick Haken/Crochet Ecoclick

Description	EAN Code	€/Unit	Unit Pack.
Bolsa/Bag 50 ganchos/hooks Ecoclick	8435104908297	15,95 €	1
Bolsa/Bag 100 ganchos/hooks Ecoclick	8435104907702	27,37 €	1
Saco/Bag 1200 ganchos/hooks Ecoclick	8435104907719	315,84 €	1

Sólo para bandejas metálicas / For metal shelves only



Tornillos+Tuercas/Bolts+Nuts/Schrauben+Muttern/Ecrous+boulons

Description	EAN Code	€/Unit	Unit Pack.
Blister 40 tornillos/bolts + tuercas/nuts (A)	8425437041105	8,15 €	10
Caja/Box 200 unids. M8 x 14 galvanizadas (B)	8425437041389	24,44 €	1
Bolsa/Bag 40 tornillos/bolts + tuercas/nuts + 4 pies grises/grey feet (C)	8425437040337	6,54 €	1



ACC07



Escuadras/Corner plate/Winkel/Équerre

Description	EAN Code	€/Unit	Unit Pack.
Blister 8 escuadras/corner plate galvaniz. (A)	8425437041099	5,18 €	30
Blister 8 escuadras/corner plate blancas/white	8425437040382	6,10 €	30
Caja/Box 48 escuadras/corner plate galvaniz.	8425437040023	14,34 €	5
Caja/Box 48 escuadras/corner plate blancas/white	8425437040405	15,92 €	5
Caja/Box 100 escuadras/corner plate galvaniz.	8425437040764	27,52 €	5
Caja/Box 100 escuadras/corner plate blancas/white (B)	8425437040399	34,67 €	5
Saco/Bag 1200 escuadras/corner plate galvaniz. (C)	8425437040412	316,32 €	1
Saco/Bag 1200 escuadras/corner plate blancas/white	8425437040429	351,48 €	1



ACC08

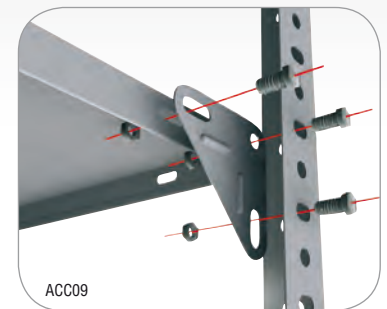

ACC09



Classic Accesories Blister

EAN Code	€/Unit	Unit Pack.
8425437048678	14,79 €	10

Included:

56 x  8 x  4 x 



Clip Accesories Blister

EAN Code	€/Unit	Unit Pack.
8425437048685	17,81 €	10

Included:

32 x  8 x  4 x  12 x 



Ruedas/Wheels/Räder/Roues

Description	EAN Code	Load Capacity* Kg (lb) Rueda/Whell	€/Unit	Unit Pack.
A *RUEDA/WHEEL ø 60mm (2.4") CON PIE Sin Freno/Without Brakes	8435104942062	40 Kg (88lb)	8,60 €	1
B *RUEDA/WHEEL ø 80mm (3.2") CON PIE Sin Freno/Without Brakes	8435104941850	70 Kg (154lb)	15,60 €	1
C *RUEDA/WHEEL ø 80mm CON PIE Con Freno/With Brakes	8435104941867	70 Kg (154lb)	19,50 €	1
D BLISTER 4 Ruedas/Wheels ø 60mm (2.4") + 8 TOR+TUE/8 BOLTS+NUTS	8435104942079	40 Kg (88lb)	40,95 €	4
E BLISTER 4 Ruedas/Wheels ø 80mm (3.2") + 8 TOR+TUE/8 BOLTS+NUTS (2 Con Freno/With Brakes + 2 Sin Freno/Without Brake)	8435104941843	70 Kg (154lb)	76,35 €	4
F BOLSA/BAG 4 Ruedas/Wheels ø 60mm (2.4") + 8 TOR+TUE/8 BOLTS+NUTS	8435104949306	40 Kg (88lb)	37,19 €	4
G BOLSA/BAG 4 Ruedas/Wheels ø 80mm (3.2") + 8 TOR+TUE/8 BOLTS+NUTS (2 Con Freno/With Brakes + 2 Sin Freno/Without Brake)	8435104949313	70 Kg (154lb)	69,20 €	4

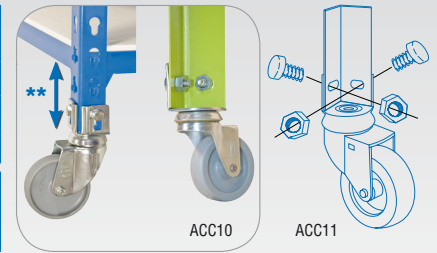

** Distancia de 1ª bandeja al suelo 80 mm (3.2")
The distance from the 1st shelf to the floor 80 mm (3.2")
Distanz vom ersten Fachboden bis zum Boden 80 mm (3.2")
Distance de la première tablette au sol 80 mm (3.2")

* Incluye 2 tornillos+tuercas y pie de anclaje.
Includes 2 bolts+nuts and a baseplate.
Mit 2 Schrauben und Muttern und Verankerungsfuss.
2 vis + écrous et pied d'ancrage inclus.

PREGUNTAR PARA OTRAS CAPACIDADES DE CARGA
OTHER LOAD CAPACITIES ON REQUEST
BEI ANDEREN TRAGLAST NACHFRAGEN
DEMANDER POUR D'AUTRES CAPACITÉS DE CHARGE



C C T B A G

Pie metálico/Metal baseplate/Stahlfuß/Pied métalliqué

Description	EAN Code	€/Unit	Unit Pack.
H *PIE METÁLICO / METAL BASEPLATE + 2 Tornillos+Tuercas / 2 Bolts+Nuts	8435104907573	1,55 €	1
I *BOLSA 4 PIES METÁLICOS / METAL BASEPLATE + 8 Tornillos+Tuercas / 8 Bolts+Nuts	8435104949320	7,68 €	1

* Incluye tornillos+tuercas y pie de anclaje.
Includes bolts+nuts and a baseplate.
Mit Schrauben und Muttern.
Vis + écrous inclus.



C C T B A G

Anclaje suelo/Anchorage/Bodenverankerung/Ancrage sol

Model	EAN Code	€/Unit	Unit Pack.
M8	8435104908440	1,09 €	1



C C T B A G

**Refuerzo soldado bandeja/Shelf welded support
Fachbodenverstärkung gelötet/Renfort soudé**

Model	Dim. mm (inch)	Ral 7046	Ral 9003	Kg/Unit (lb/Unit)	€/Unit	Unit Pack.
Omega soldado	600 (23.6")	8425437041402	8425437042065	0,35 (0.8")	3,17 €	10
Omega soldado	700 (27.6")	8425437041433	8425437041419	0,41 (0.9")	3,17 €	10
Omega soldado	800 (31.5")	8425437041464	8425437041440	0,47 (1.0")	3,17 €	10
Omega soldado	900 (35.4")	8425437041495	8425437041471	0,53 (1.2")	3,17 €	10
Omega soldado	1000 (39.4")	8425437041525	8425437041501	0,59 (1.3")	4,23 €	10
Omega soldado	1100 (43.3")	8425437041556	8425437041532	0,65 (1.4")	4,23 €	10
Omega soldado	1200 (47.2")	8425437041587	8425437041563	0,71 (1.6")	4,23 €	10

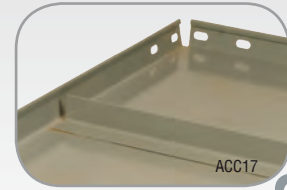
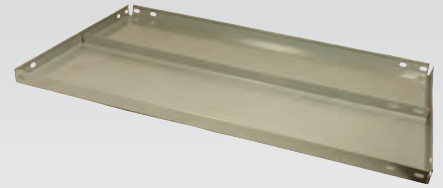

C G

**Refuerzo atornillado bandeja/Shelf screwed support
Fachbodenverstärkung geschraubt/Renfort boulonné**

Model	Dim. mm (inch)	Ral 7046	Ral 9003	Kg/Unit (lb/Unit)	€/Unit	Unit Pack.
Omega atornillado	600 (23.6")	8425437041617	8425437041594	0,35 (0.8")	3,61 €	10
Omega atornillado	700 (27.6")	8425437041648	8425437041624	0,41 (0.9")	3,61 €	10
Omega atornillado	800 (31.5")	8425437041679	8425437041655	0,47 (1.0")	3,61 €	10
Omega atornillado	900 (35.4")	8425437041709	8425437041686	0,53 (1.2")	3,61 €	10
Omega atornillado	1000 (39.4")	8425437041730	8425437041716	0,59 (1.3")	4,73 €	10
Omega atornillado	1100 (43.3")	8425437041761	8425437041754	0,65 (1.4")	4,73 €	10
Omega atornillado	1200 (47.2")	8425437041792	8425437041778	0,71 (1.6")	4,73 €	10

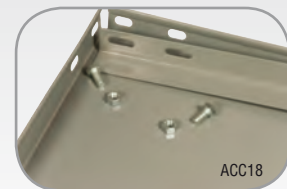
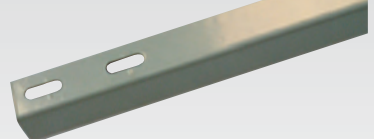
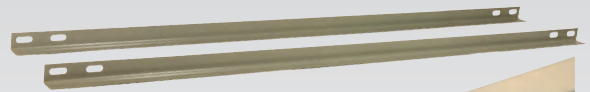

C G

* No incluye tornillos.
Does not include screws.
Enthält keine Schrauben.
Ne comprend pas les vis.

Martillo nylon/Nylon hammer/Kunststoffhammer/Nylon marteau

EAN Code	€/Unit	Unit Pack.
8435104921203	11,40 €	1



C T B O A H G

Colgador barra/Garment rail/Tragestange/Barre de suspension

Description	EAN Code	€/Unit	Unit Pack.
J Simonclick/Officlick (A)	8435104908181	4,21 €	1
K Taller (B)	8435104907542	4,21 €	1



C
O
G

T



Barra/Rail/Stange/Barra/Barre

Description Dim. mm (inch)	EAN Code	€/Unit	Unit Pack.
Barra/Rail 900 mm (35.4")	8435104907559	5,43 €	1
Barra/Rail 1200 mm (47.2")	8435104907566	8,10 €	1
Barra/Rail 1500 mm (59.1")	8435104909355	9,08 €	1



ACC21

C C T O G

Larguero Colgador Barra/Garment rail beam/Stangenhalter/Cintre avec traverse

Description	Ral 5015	Ral 2004	Ral 7046	Ral 9003	Zinc.-Galv.	€/Unit	Unit Pack.
Colgador / Garment 1 barra /rail beam 300 mm (11.8")	8435104919989	8435104931028	8435104931097	8435104931165	8435104931233	2,96 €	1
Colgador / Garment 1 barra /rail beam 400 mm (15.8")	8435104930663	8435104931035	8435104931103	8435104931172	8435104931240	4,30 €	1
Colgador / Garment 3 barras /rail beam 450 mm (17.7")	8435104927618	8435104931042	8435104931110	8435104931189	8435104931257	4,84 €	1
Colgador / Garment 3 barras /rail beams 500 mm (19.7")	8435104930670	8435104931059	8435104931127	8435104931196	8435104931264	5,37 €	1
Colgador / Garment 3 barras /rail beams 600 mm (23.6")	8435104919996	8435104931066	8435104931134	8435104931202	8435104931271	6,72 €	1
Colgador / Garment 3 barras /rail beams 750 mm (29.5")	8435104920008	8435104931073	8435104931141	8435104931219	8435104931288	8,25 €	1
Colgador / Garment 3 barras /rail beams 900 mm (35.4")	8435104920015	8435104931080	8435104931158	8435104931226	8435104931295	10,48 €	1

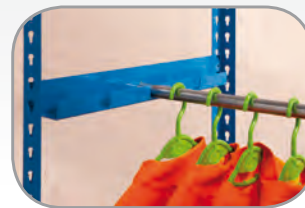
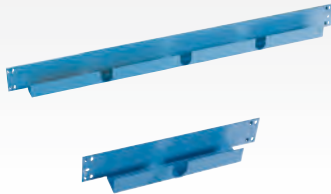

ACC22

ACC23

C T O G

Carpetas colgantes/Hanging folders/Hängeregister/Dossiers suspendus

Description	EAN Code	€/Unit	Unit Pack.
C-330 A4 Pack 10 units	8435104914229	43,92 €	1
C-330 A4 Caja/Box 100 units	8435104914236	222,23 €	1
C-365 Pack 10 units	8435104945612	43,92 €	1
C-365 Caja/Box 100 units	8435104945629	222,23 €	1

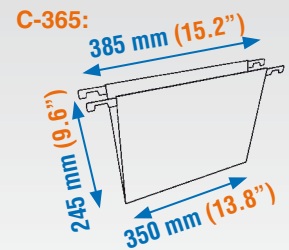
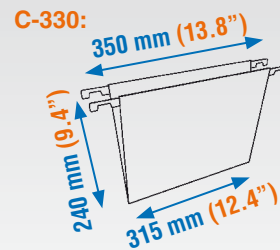

C-330

C-365

C C T O H G

Varillas para carpetas colgantes/Rod hanging folders System für Hängeregister/Tiges pour dossiers suspendus

Model	Dim. mm (inch)	Ral 5015	Ral 7046	Ral 9003	Kg/Unit (lb/Unit)	€/Unit
V-330	900 (35.4")	8435104913901	8435104945292	8435104945360	0,98 (2.2)	4,97 €
	1000 (39.4")	8435104913918	8435104945308	8435104945377	0,98 (2.2)	5,19 €
	1200 (47.2")	8435104931578	8435104945322	8435104945391	0,98 (2.2)	5,56 €
V-365	900 (35.4")	8435104945438	8435104945506	8435104945575	0,98 (2.2)	4,97 €
	1000 (39.4")	8435104945445	8435104945513	8435104945582	0,98 (2.2)	5,19 €
	1200 (47.2")	8435114945452	8435104945537	8435104945605	0,98 (2.2)	5,56 €



2 Tornillos+tuerca incluidos por varilla
Includes 2 bolts+nuts per rod
2 Schraube + Mutter für Stab enthalten
2 Vis + écrou pour tige fournie

Otras medidas consultar
Other measurements on request
Bei anderen Abmessungen nachfragen
Autres mesures sur demande

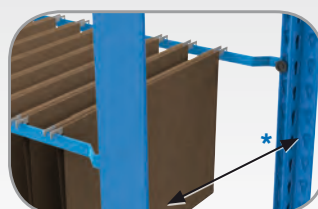

ACC24

* 400 mm (15.8")



ACC25

C C T O H G

Tapas laterales/Lateral plug/Seitenabdeckung/Panneaux latéraux

Dim. mm (inch)	Ral 7046	Ral 9003	Ral 5015	Kg/Unit (lb/Unit)	€/Unit	Unit Pack.
1000 x 300 (39.4"x11.8")	8435104913789	8435104913826	8435104913741	2,68 (5.91)	18,17 €	4
1000 x 400 (39.4"x15.8")	8435104913796	8435104913833	8435104913758	3,30 (7.28)	24,04 €	4
1500 x 300 (59.1"x11.8")	8435104913802	8435104913840	8435104913765	4,01 (8.84)	30,46 €	4
1500 x 400 (59.1"x15.8")	8435104913819	8435104913857	8435104913772	4,95 (10.91)	31,95 €	4
2000 x 300 (78.7"x11.8")	8435104927441	8435104927458	8435104927472	5,35 (11.79)	36,93 €	4
2000 x 400 (78.7"x15.8")	8435104918418	8435104927465	8435104927489	6,61 (14.57)	38,11 €	4

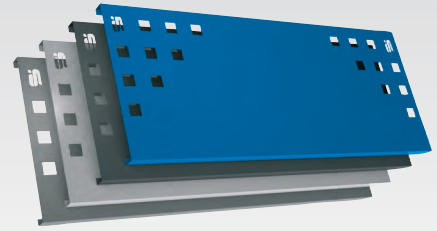

ACC26



ACC27



ACC28



ACC29



ACC30



Chapa lateral y trasera/Side and back sheet
Seite - und Wandabdeckungsblech/Plaque latérale et arrière

Dim. mm (inch)	Ral 7046	Ral 9003	Ral 5015	Zinc-Galv.	Kg/Unit (lb/Unit)	€/Unit	Unit Pack.
1000 x 300 (39.4"x11.8")	8435104926154	8435104926062	8435104926246	8435104918517	1,85 (4.08)	12,80 €	1
1000 x 400 (39.4"x15.8")	8435104926161	8435104926079	8435104926253	8435104918524	2,47 (5.45)	17,07 €	1
1000 x 500 (39.4"x19.7")	8435104926178	8435104926086	8435104926260	8435104918531	3,10 (6.83)	21,33 €	1
1000 x 600 (39.4"x23.6")	8435104926185	8435104926093	8435104926277	8435104918548	3,73 (8.22)	24,79 €	1
1000 x 900 (39.4"x35.4")	8435104926215	8435104926123	8435104926307	8435104918579	5,61 (12.37)	38,40 €	1
1000 x 1000 (39.4"x39.4")	8435104926222	8435104926130	8435104926314	8435104918586	6,23 (13.73)	42,66 €	1

* Otras medidas consultar/Other measurements on request/Bei anderen Abmessungen nachfragen/Autres mesures sur demande



ACC31



Bandeja de tramex/Tramex shelf
Tramex boden/Plateau tramex



ACC39

Bandeja de reja/Shelf bars
Gitter boden/Plateau Grillage



ACC34



ACC35



**BAJO PRESUPUESTO
QUOTATIONS ON REQUEST
NACH PREISANFRAGE
SUR DEMANDE**

Zócalos/Socles/Socket/Socles

Dim. mm (inch)	Ral 7046	Ral 9003	Ral 5015	Zinc-Galv.	Kg/Unit (lb/Unit)	€/Unit	Unit Pack.
300 x 100 (11.8"x3.9")	8435104913048	8435104913147	8435104912898	8435104913246	0,25 (0.6)	2,08 €	10
400 x 100 (15.8"x3.9")	8435104913055	8435104913154	8435104912904	8435104913253	0,33 (0.7)	3,21 €	10
500 x 100 (19.7"x3.9")	8435104913062	8435104913161	8435104912928	8435104913260	0,42 (0.9)	4,32 €	10
600 x 100 (23.6"x3.9")	8435104913079	8435104913178	8435104912935	8435104913277	0,50 (1.1)	6,30 €	10
700 x 100 (27.6"x3.9")	8435104913086	8435104913185	8435104912942	8435104913284	0,59 (1.3)	6,55 €	10
800 x 100 (31.5"x3.9")	8435104913093	8435104913192	8435104912966	8435104913291	0,67 (1.5)	7,66 €	10
900 x 100 (35.4"x3.9")	8435104913109	8435104913208	8435104912973	8435104913307	0,76 (1.7)	8,77 €	10
1000 x 100 (39.4"x3.9")	8435104913116	8435104913215	8435104912980	8435104913314	0,84 (1.9)	9,89 €	10
1100 x 100 (43.3"x3.9")	8435104913123	8435104913222	8435104912997	8435104913321	0,92 (2.0)	11,00 €	10
1200 x 100 (47.2"x3.9")	8435104913130	8435104913239	8435104913000	8435104913338	1,01 (2.2)	12,11 €	10



C C T B O A G

Frontis/Bands/Schützfront/Bandes

Model	Dim. mm (inch)	Ral 7046	Ral 9003	Ral 5015	Zinc-Galv.	Kg/Unit (lb/Unit)	€/Unit	Unit Pack.
Delantero/Forward	600 x 100 (23.6"x3.9")	8425437009075	8425437009129	8435104927212	8435104927274	0,50 (1.1)	5,00 €	10
Delantero/Forward	700 x 100 (27.6"x3.9")	8425437009082	8425437009136	8435104927229	8435104927281	0,59 (1.3)	6,27 €	10
Delantero/Forward	800 x 100 (31.5"x3.9")	8425437009099	8425437009143	8435104927236	8435104927298	0,67 (1.5)	6,38 €	10
Delantero/Forward	900 x 100 (35.4"x3.9")	8425437009105	8425437009150	8435104927243	8435104927304	0,76 (1.7)	7,73 €	10
Delantero/Forward	1000 x 100 (39.4"x3.9")	8425437009112	8425437009167	8435104927250	8435104927311	0,84 (1.9)	8,02 €	10
Delantero/Forward	1200 x 100 (47.2"x3.9")	8435104926987	8435104926994	8435104927267	8435104927328	1,01 (2.2)	11,70 €	10
Trasero/Back	600 x 220 (23.6"x8.7")	8425437009327	8425437009372	8435104927090	8435104927151	0,95 (2.1)	10,36 €	10
Trasero/Back	700 x 220 (27.6"x8.7")	8425437009334	8425437009389	8435104927106	8435104927168	1,11 (2.5)	11,35 €	10
Trasero/Back	800 x 220 (31.5"x8.7")	8425437009341	8425437009396	8435104927113	8435104927175	1,27 (2.8)	11,79 €	10
Trasero/Back	900 x 220 (35.4"x8.7")	8425437009358	8425437009402	8435104927120	8435104927182	1,43 (3.2)	12,29 €	10
Trasero/Back	1000 x 220 (39.4"x8.7")	8425437009365	8425437009419	8435104927137	8435104927199	1,59 (3.5)	13,21 €	10
Trasero/Back	1200 x 220 (47.2"x8.7")	8435104927038	8435104927045	8435104927144	8435104927205	1,91 (4.2)	19,14 €	10

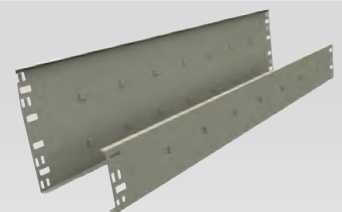

Divisores de frontis/Bands dividers/Front-Trenner/Diviseur d'étagère

Model	Dim. mm (inch)	Ral 7046	Ral 9003	Ral 5015	Zinc-Galv.	Kg/Unit (lb/Unit)	€/Unit	Unit Pack.
200	200 x 100 / 220 (7.9" x 3.9" / 8.7")	8425437009570	8425437009624	8435104924280	8435104924334	0,23 (0.5)	4,07 €	10
300	300 x 100 / 220 (11.8" x 3.9" / 8.7")	8425437009587	8425437009631	8435104924297	8435104924341	0,34 (0.7)	4,13 €	10
400	400 x 100 / 220 (15.8" x 3.9" / 8.7")	8425437009594	8425437009648	8435104924303	8435104924358	0,45 (1.0)	4,21 €	10
500	500 x 100 / 220 (19.7" x 3.9" / 8.7")	8425437009600	8425437009655	8435104924310	8435104924365	0,55 (1.2)	4,92 €	10
600	600 x 100 / 220 (23.6" x 3.9" / 8.7")	8425437009617	8425437009662	8435104924327	8435104924372	0,66 (1.5)	5,18 €	10

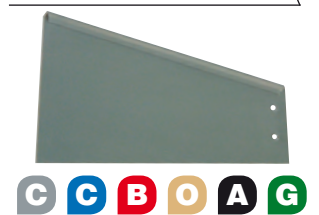

C C B O A G

Divisores de pestaña/Wall dividers/Wandtrenner/Séparation coulissante

Dim. mm (inch)	Ral 7046	Ral 9003	Ral 5015	Zinc-Galv.	Kg/Unit (lb/Unit)	€/Unit	Unit Pack.
200 x 200 (7.9"x7.9")	8425437009822	8425437009877	8435104924129	8435104924174	0,51 (1.1)	4,89 €	20
300 x 200 (11.8"x7.9")	8425437009839	8425437009884	8435104914014	8435104924181	0,78 (1.7)	5,74 €	20
400 x 200 (15.8"x7.9")	8425437009846	8425437009891	8435104914021	8435104924198	1,04 (2.3)	7,04 €	20
500 x 200 (19.7"x7.9")	8425437009853	8425437009907	8435104924150	8435104924204	1,31 (2.9)	8,49 €	20
600 x 200 (23.6"x7.9")	8425437009860	8425437009914	8435104924167	8435104924211	1,57 (3.5)	9,51 €	20



ACC39



ACC40



ACC41

C C B O A H G

Panel perforado/Perforated shelf/Lochblech/Panneau perforé

Dim. mm (inch)	Ral 7046	Ral 9003	Ral 5015	Zinc-Galv.	Kg/Unit (lb/Unit)	€/Unit	Unit Pack.
900 x 400 (35.4"x15.8")	8435104919033	8435104919156	8435104919279	8435104919392	2,95 (6.5)	13,89 €	1
900 x 600 (35.4"x23.6")	8435104919057	8435104919170	8435104919293	8435104919415	4,18 (9.2)	22,34 €	1
1200 x 400 (47.2"x15.8")	8435104919118	8435104919231	8435104919354	8435104919477	3,86 (8.5)	20,17 €	1
1200 x 600 (47.2"x23.6")	8435104919132	8435104919255	8435104919378	8435104919491	5,47 (12.1)	30,04 €	1
1500 x 400 (59.1"x15.8")	8435104926628	8435104926635	8435104926642	8435104926659	4,76 (10.5)	23,40 €	1
1500 x 600 (59.1"x23.6")	8435104921654	8435104926673	8435104921661	8435104921678	6,75 (14.9)	32,30 €	1

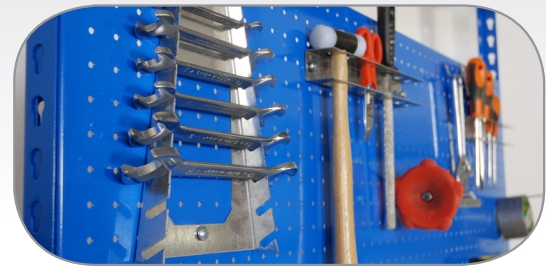

C C T B O A G

Ganchos/Hooks/Crochets

Description	EAN Code	€/Unit	Unit Pack.
A BOLSA 8 ganchos/hooks dobles	8435104949337	8,83 €	1
B BOLSA 10 ganchos/hooks simples	8435104949344	5,35 €	1
A1 6 Hook01 (A1) Gancho Doble T 100	8435104918623	10,27 €	1
A1 6 Hook02 (A1) Gancho Doble T 150	8435104918630	9,54 €	1
A2 6 Hook03 (A2) Gancho Doble U 100	8435104918647	6,37 €	1
A2 6 Hook04 (A2) Gancho Doble U 150	8435104918654	7,29 €	1
B1 10 Hook05 (B1) Gancho Sencillo V	8435104918678	6,59 €	1
B2 10 Hook06 (B1) Gancho Sencillo U	8435104918661	6,59 €	1

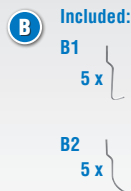
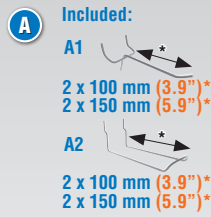

C C T B O A G

Accesorios Panel Click/Panel Click Accessories/Zubehör Panel Click/Accessoires Panneau Click

Description W x D x H	EAN Code	€/Unit	Unit Pack.
ACC 001 340 x 162 x 43 mm (13.4" x 6.4" x 1.7")	8435104933435	6,39 €	1
ACC 002 220 x 38 x 35 mm (8.7" x 1.5" x 1.4")	8435104941898	2,58 €	1
ACC 003 282 x 35 x 35 mm (11.1" x 1.4" x 1.4")	8435104933411	3,20 €	1
ACC 004 220 x 38 x 35 mm (8.7" x 1.5" x 1.4")	8435104933428	2,58 €	1
ACC 005 132 x 65 x 15 mm (5.2" x 2.6" x 0.6")	8435104933442	1,44 €	1
ACC 011 145 x 50 x 52 mm (5.7" x 2.0" x 2.1")	8435104942789	2,58 €	1
ACC 010 BLISTER 4 Acces BT-PANEL	8435104941881	22,20 €	1
BOLSA ACC. PANELCLICK 9 PIEZAS 260x300x40 mm (10.2" x 11.8" x 1.6")	8435104943915	14,95 €	1

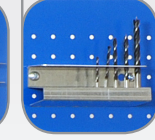
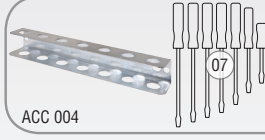
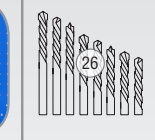
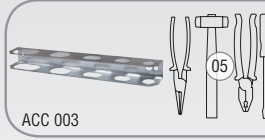
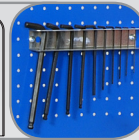
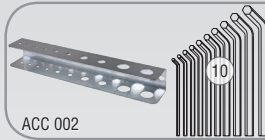
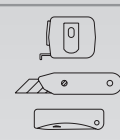

C C T B O A G

Gavetas/Storage bins/Schubfächer/Bacs plastiques

Description - Dim. mm (inch)	EAN Code	€/Unit	Unit Pack.
Blister 5 gavetas/storage bins 52 x 100 x 95 mm (2.1" x 3.9" x 3.7")	8435104927052	11,54 €	1
Blister 5 gavetas/storage bins 80 x 100 x 170 mm (3.2" x 3.9" x 6.7")	8435104927069	19,41 €	1



ACC48

C C O T B G

Imanes Ferrita/Magnets Ferrita/Magnete Ferrita/Aimants Ferrita

Description	W x D x H Dim. mm ø (Inch ø)	EAN Code	Kg/Unit (lb/Unit)	€/Unit	Unit Pack.
BLISTER 8 IMANES PANEL/ BLISTER 8 MAGNETS PANEL	25 mm ø (1.0" ø)	8435104949351	0,30 (0.7)	5,70 €	1



ACC49

C C T B O A H G

Zócalos BT/Socles BT/Socket BT/Socles BT

BT (BT-1/BT-2/BT-3/BT-4/BT-5/BT-7)					
Model	Dim. mm (inch)	EAN Code	Kg/Unit (lb/Unit)	€/Unit	Unit Pack.
ZOCALO BT 600	600 x 100 (23.6"x3.9")	8435104934012	0,50 (1.1)	6,10 €	1
ZOCALO BT 750	750 x 100 (29.5"x3.9")	8435104934029	0,63 (1.4)	6,61 €	1
ZOCALO BT 900	900 x 100 (35.4"x3.9")	8435104934036	0,76 (1.7)	8,50 €	1
ZOCALO BT 1200	1200 x 100 (47.2"x3.9")	8435104934043	1,01 (2.2)	11,73 €	1
ZOCALO BT 1500	1500 x 100 (59.1"x3.9")	8435104934050	1,26 (2.8)	14,97 €	1
ZOCALO BT 1800	1800 x 100 (70.9"x3.9")	8435104934067	1,51 (3.3)	17,00 €	1

BT-6					
Model	Dim. mm (inch)	EAN Code	Kg/Unit (lb/Unit)	€/Unit	Unit Pack.
ZOCALO BT-6 1200	1200 x 100 (47.2"x3.9")	8435104937655	1,38 (3.0)	12,85 €	1
ZOCALO BT-6 1500	1500 x 100 (59.1"x3.9")	8435104937662	1,72 (3.8)	16,13 €	1
ZOCALO BT-6 1800	1800 x 100 (70.9"x3.9")	8435104937679	2,07 (4.6)	18,39 €	1



ACC50



ACC51

B

Chapa metálica/Metal sheet/Blech/Tôle

W x D Dim. mm (inch)	EAN Code	Kg/Unit (lb/Unit)	€/Unit
900 x 600 (35.4"x23.6")	8435104919880	3,68 (8.1)	21,16 €
900 x 750 (35.4"x29.5")	8435104919910	4,56 (10.0)	25,11 €
1200 x 600 (47.2"x23.6")	8435104919897	4,87 (10.7)	27,41 €
1200 x 750 (47.2"x29.5")	8435104919927	6,03 (13.3)	32,86 €
1500 x 600 (59.1"x23.6")	8435104919903	6,05 (13.3)	33,81 €
1500 x 750 (59.1"x29.5")	8435104919934	7,49 (16.5)	41,14 €



ACC52



ACC53

C T B O A

Cajones/Drawer/Schublade/Tiroirs

BOX PARA*(BT0/BT1/BT2/BT3/BT4/BT5/SIMONCLICK/SIMONTALLER)				
Model	W x D Dim. mm (inch)	EAN Code	Kg/Unit (lb/Unit)	€/Unit
BOX 900x600	772 x 565 (30.4"x22.2")	8435104934074	7,56 (16.7)	52,00 €
BOX 900x750	772 x 565 (30.4"x22.2")	8435104934104	7,89 (17.4)	52,00 €
BOX 1200x600	1072 x 565 (42.2"x22.2")	8435104934081	9,03 (19.9)	58,10 €
BOX 1200x750	1072 x 565 (42.2"x22.2")	8435104934111	9,36 (20.6)	58,10 €
BOX 1500x600	1372 x 565 (54.0"x22.2")	8435104934098	10,50 (23.1)	64,74 €
BOX 1500x750	1372 x 565 (54.0"x22.2")	8435104934128	10,83 (23.9)	64,74 €

*Comprend 2 Guides + 2 Beams

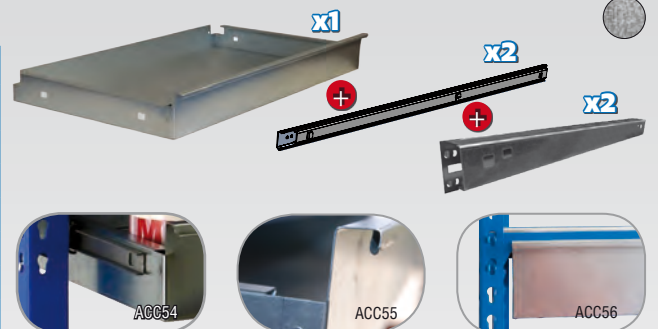

BOX PARA BT6 PLYWOOD / METAL**				
Model	W x D Dim. mm (inch)	EAN Code	Kg/Unit (lb/Unit)	€/Unit
BOX BT6 (1200/1500/1800)	860 x 490 (33.9" x 19.3")	8435104947074	6,59 (14.5)	48,00 €

**Comprend 2 Guides



*** GUÍA TELESCÓPICA / TELESCOPIC GUIDE / TELESKOPFÜHRUNG / GUIDE TÉLESCOPIQUE

C T B O A G

Cajones/Drawer/Schublade/Tiroirs

Model	Dim. mm (inch)	Ral 7046	Ral 9003	Ral 5015	Kg/Unit (lb/Unit)	€/Unit	Unit Pack.
C / 30 - 100	100 x 300 x 100 (3.9"x11.8"x3.9")	8425437064050	8425437064081	8425437064111	0,93 (2.0)	8,71 €	2
C / 40 - 100	100 x 400 x 100 (3.9"x15.7"x3.9")	8425437064067	8425437064098	8425437064128	1,10 (2.4)	9,27 €	2
C / 50 - 100	100 x 500 x 100 (3.9"x19.7"x3.9")	8425437064074	8425437064104	8425437064135	1,28 (2.8)	13,33 €	2
C / 30 - 200	200 x 300 x 100 (7.9"x11.8"x3.9")	8425437008498	8425437008559	8435104924259	1,25 (2.8)	10,25 €	2
C / 40 - 200	200 x 400 x 100 (7.9"x15.8"x3.9")	8425437008504	8425437008566	8435104924266	1,49 (3.3)	10,91 €	2
C / 50 - 200	200 x 500 x 100 (7.9"x19.7"x3.9")	8425437008511	8425437008573	8435104924273	1,73 (3.8)	15,68 €	2
C / 30 - 270	270 x 300 x 100 (10.6"x11.8"x3.9")	8425437008528	8425437008580	8435104924228	1,48 (3.3)	12,00 €	2
C / 40 - 270	270 x 400 x 100 (10.6"x15.8"x3.9")	8425437008535	8425437008597	8435104924235	1,76 (3.9)	11,29 €	2
C / 50 - 270	270 x 500 x 100 (10.6"x19.7"x3.9")	8425437008542	8425437008603	8435104924242	2,05 (4.5)	16,49 €	2

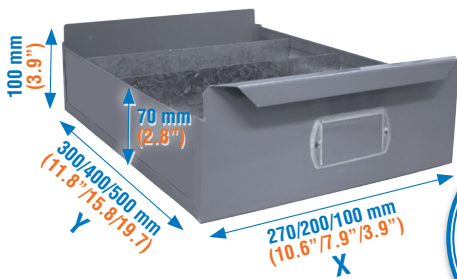
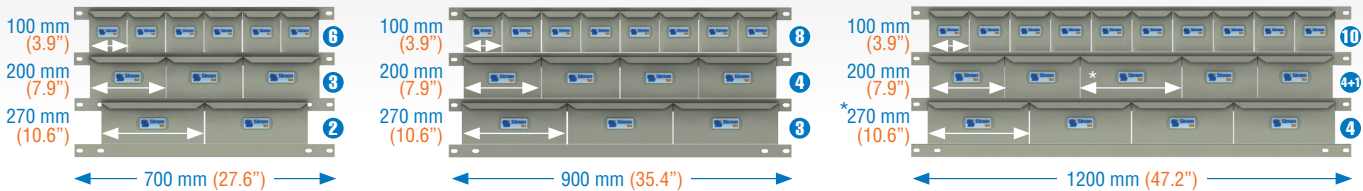

Divisores de cajón/Drawers dividers/Schubladentrenner/Diviseurs pour tiroirs

Model	Dim. mm (inch)	Bin X	EAN Code	Kg/Unit (lb/Unit)	€/Unit	Unit Pack.
Transversal*	100 x 70 (3.9"x2.8")	Bin X = 100 mm (3.9")	---	-- --	--	--
Transversal*	200 x 70 (7.9"x2.8")	Bin X = 200 mm (7.9")	8425437008757	0,30 (0.6)	0,88 €	25
Transversal*	270 x 70 (10.6"x2.8")	Bin X = 270 mm (10.6")	8425437008764	0,30 (0.7)	1,17 €	25
Longitudinal#	300 x 70 (11.8"x2.8")	Bin Y = 300 mm (11.8")	8425437008931	0,37 (0.8)	1,18 €	25
Longitudinal#	400 x 70 (15.8"x2.8")	Bin Y = 400 mm (15.8")	8425437008948	0,49 (1.1)	1,42 €	25
Longitudinal#	500 x 70 (19.7"x2.8")	Bin Y = 500 mm (19.7")	8425437008955	0,62 (1.4)	1,93 €	25

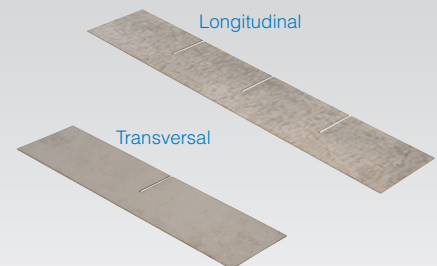

* Máximo 2 para fondo 300mm (11.8"), 3 para 400mm (15.8") y 4 para 500 mm (19.7")
Mínimo 2 transversales para 1 longitudinal.
* 300 (11.8") depth - maximum 2 dividers, 400mm (15.8") depth - maximum 3 dividers, 500 (19.7") depth - maximum 4 dividers.
2 cross dividers minimum for 1 longitudinal.
* Maximal 2 bei Tiefe von 300mm (11.8"), 3 bei Tiefe von 400mm (15.8") und 4 bei Tiefe von 500 mm
Minimum 2 transversalen für ein longitudinal.
* 2 maximum pour une profondeur de 300mm (11.8"), 3 pour 400mm (15.8") et 4 pour une profondeur de 500mm (19.7").
Minimum de 2 transversales par longueur.

Máximo 1 por cajón.
1 longitudinal maximum per shelve.
Maximal 1 pro Schublade.
Maximum 1 per tiroir.

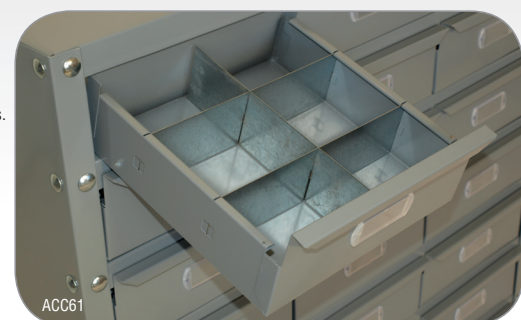

Funda estantería/Wardrobe cover/Regalbezug/Housse pour étagère

Dim. mm (inch)	EAN Code	€/Unit	Unit Pack.
1800 x 900 x 300 (70.9"x35.4"x11.8")	8425437048043	10,27 €	1
1800 x 900 x 400 (70.9"x35.4"x15.8")	8425437048036	10,79 €	1
1800 x 900 x 500 (70.9"x35.4"x19.7")	8425437048579	11,36 €	1
2000 x 1000 x 300 (78.7"x39.4"x11.8")	8425437048067	12,45 €	1
2000 x 1000 x 400 (78.7"x39.4"x15.8")	8425437048050	13,44 €	1
2000 x 1000 x 500 (78.7"x39.4"x19.7")	8425437048074	14,16 €	1



C T
O G

Organizador lateral
Shelf storage side unit
Aufbewahrungselement
Pochettes latérales

Dim. mm (inch)	EAN Code	€/Unit	Unit Pack.
1690 x 350 mm (66.5" x 13.8")	8435104926437	6,17 €	1



C C T O A H G

Etiqueta magnética/Magnetic label
Magnetisches Etikett/Etiquettes magnétiques

Description	Dim. mm (inch)	EAN Code	€/Unit	Unit Pack.
R Etiqueta magnética/ Magnetic label	1000 x 25 mm (39.4" x 1.0")	8435104907603	8,00 €	1
S BLISTER 20 Label Magnetic	60 x 30mm (2.4" x 1.2")	8435104949504	7,16 €	1



C C T B O A H G

Espaciador telescópico/Telescoping spacer
Teleskop-Abstandshalter/Télescopique entretoise

Dim. mm (inch)	EAN Code	€/Unit	Unit Pack.
74x330x30 (2.9"x13.0"x1.2")	8435104945650	11,85 €	1

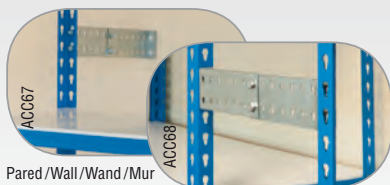

Pared/Wall/Wand/Mur

Estanterías/Shelving/Regale/Rayonnage

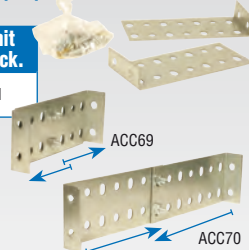

C C T
O A G

Unión modulo en esquina/Union Corner module
Union Corner Modul/Module Union Corner

Dim. mm (inch)	EAN Code	€/Unit	Unit Pack.
64x30x12mm (2.5"x1.2"x0.5")	8435104945667	1,45 €	1



C O

Pletina de unión/Union plate/Verbindungsplatte/Plaque d'union

Description	EAN Code	€/Unit	Unit Pack.
Double 1 unit. (A)*	8435104911990	1,31 €	1
Blister 2 units. (B)*	8435104925966	3,16 €	1
Single 1 unit (C)	8435104944714	0,84 €	1

* Incompatible pies dobles / Incompatible double feet
Inkompatible Doppel Füße / Pieds doubles Incompatibilité

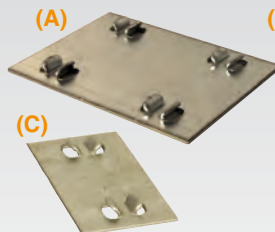

C T A G

Pin de unión/Bay connector/Verbindungsstift/Inserts de liaison

Description	EAN Code	€/Unit	Unit Pack.
Bolsa/Bag 20 units.	8435104908204	19,46 €	1
Bolsa/Bag 50 units.	8435104908198	48,65 €	1

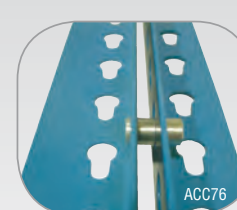

C T A G